



Two impeller centrifugal pumps for constructing pressurisation systems for civil and industrial plant; the two counter-posed impellers guarantee high head and flow rate.

Construction features

Pump body	cast iron
Motor bracket	cast iron
Impeller	Noryl® or brass (100÷900) brass (750÷1500)
Mechanical seal	ceramic-graphite-NBR
Motor shaft	stainless steel AISI 303 stainless steel AISI 416 (100)
Liquid temperature	Noryl® impeller: 0 - 50 °C brass impeller: 0 - 90 °C
Operating pressure	max 6 bar (100) max 11 bar (160-1500)

Motor

	3~ 230/400V-50Hz P ≤ 4kW
2 Poles induction motor	1~ 230V-50Hz (with thermal protection up to MEC 80)
Insulation class	F
Protection degree	IPX4 IPX5 (KB750÷1500)

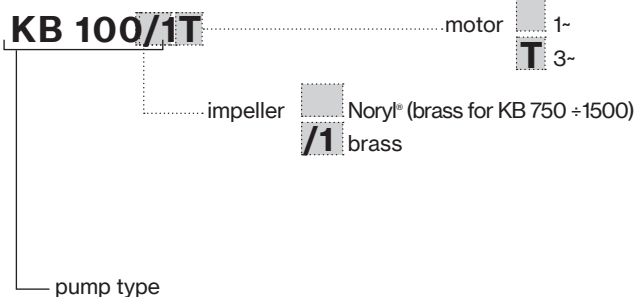

TYPE	LOTS		CONTAINER	
	PALLET (cm)	N° pumps	PALLET (cm)	N° pumps
KB 100	90×110×145	65	90×110×195	91
KB 160- KB 310 T	85×110×130	40	85×110×190	60
KB 310	85×110×150	24	85×110×180	30
KB 400-900	80×120×150	24	80×120×180	30
KB 800-1500 T	100×120×140	18	100×120×185	24



KB

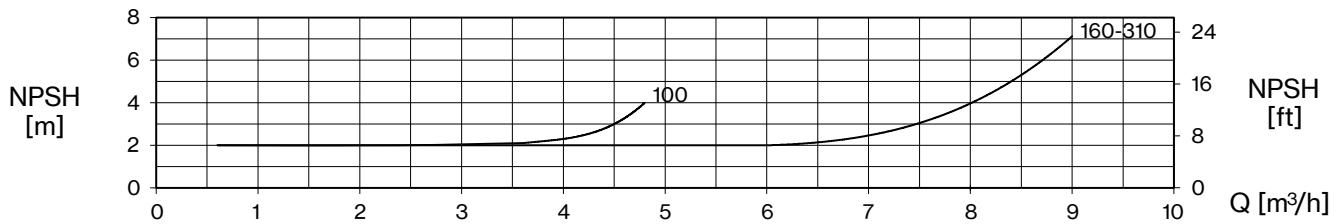
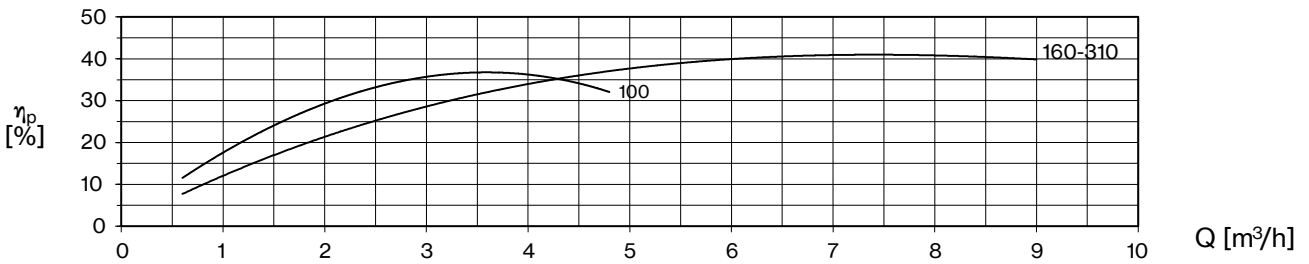
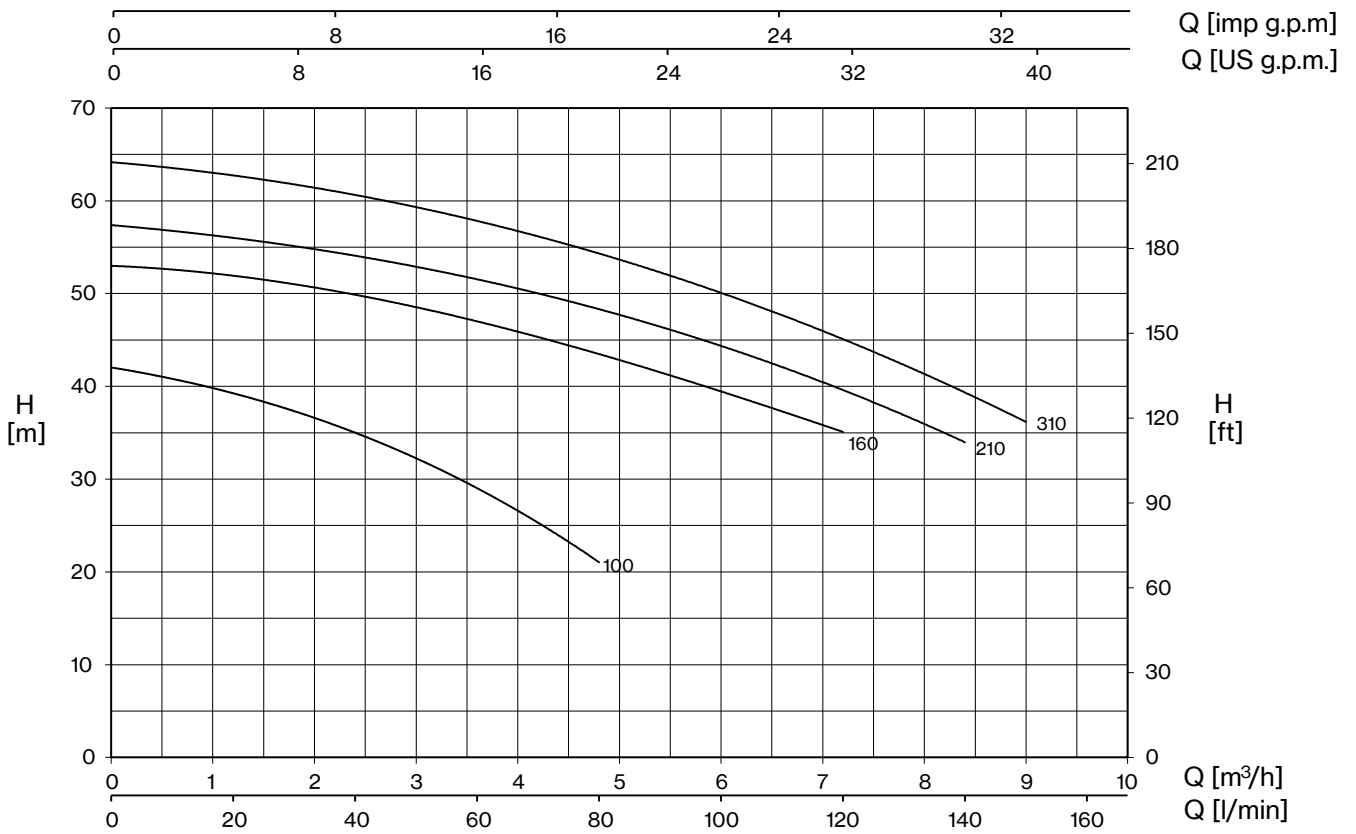

TYPE		P2		P1 (kW)		AMPERE		Q (m³/h - l/min)											
1~	3~					1~	3~	0	0,6	1,2	1,8	2,4	3,6	4,8	6	7,2	8,4	9	
		HP	kW	1~	3~	1x230 V 50 Hz	3x400 V 50 Hz	0	10	20	30	40	60	80	100	120	140	150	
								H (m)											
KB 100	KB 100 T	1	0,74	1,17	1,15	5,4	2,4	42,0	40,8	39,4	37,4	34,7	29,2	21,0					
KB 160	KB 160 T	1,5	1,1	2,3	2,2	10,2	4,1	53,0	52,5	52,0	51,0	50,0	46,9	43,3	39,7	35,0			
KB 210	KB 210 T	2	1,5	2,6	2,45	11,5	4,8	57,3	56,9	56,0	55,1	54,0	51,5	48,4	44,4	39,5	34,0		
KB 310	KB 310 T	3	2,2	2,9	2,8	13,2	5,2	64,0	63,5	63,0	61,9	60,6	57,7	54,1	50,0	45,4	39,4	36,0	

Q [imp g.p.m]
Q [US g.p.m.]

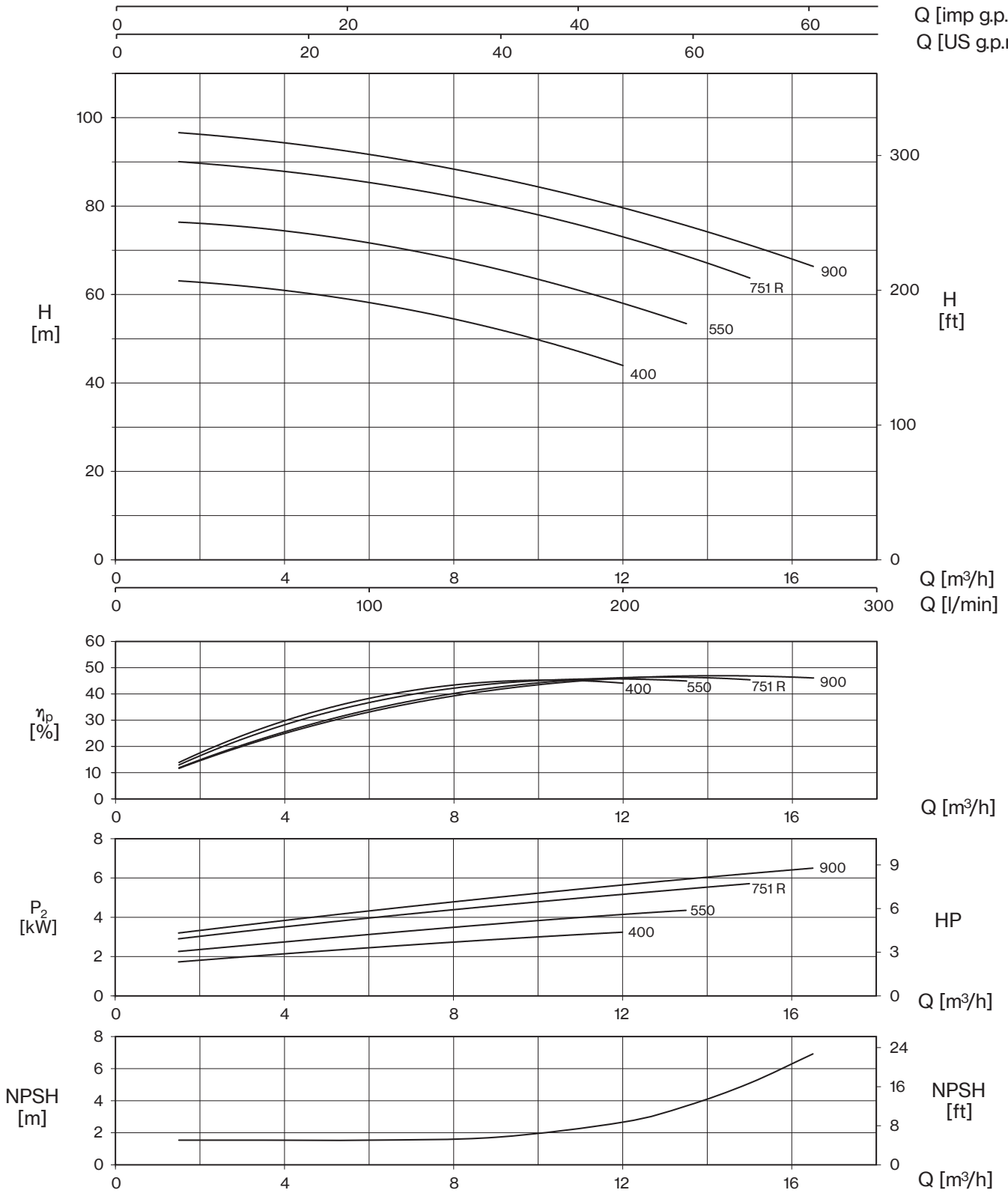

TYPE		P2		P1 (kW)		AMPERE		Q (m³/h - l/min)															
1~	3~					1~	3~	0	1,5	3,0	4,5	6,0	7,5	9,0	10,5	12	13,5	15,0	16,5				
						1x230 V 50 Hz	3x400 V 50 Hz	0	25	50	75	100	125	150	175	200	225	250	275				
								H (m)															
KB 400	KB 400 T	4	3,0	3,7	3,8	16,4	6,7	63,6	63,1	62,0	60,3	58,2	55,5	52,3	48,4	43,9							
KB 550	KB 550 T	5,5	4,0	5,2	5,0	23,3	9,1	76,9	76,4	75,4	73,8	71,7	69,0	65,9	62,1	58,0	53,4						
-	KB 751RT	7,5	5,5	-	6,5	-	11,5	90,7	90,0	88,9	87,3	85,3	82,9	80,1	76,8	73,1	68,8	63,7					
-	KB 900 T	10	7,5	-	7,3	-	13,3	97,5	96,6	95,4	93,7	91,7	89,2	86,5	83,3	79,8	75,2	71,2	66,4				

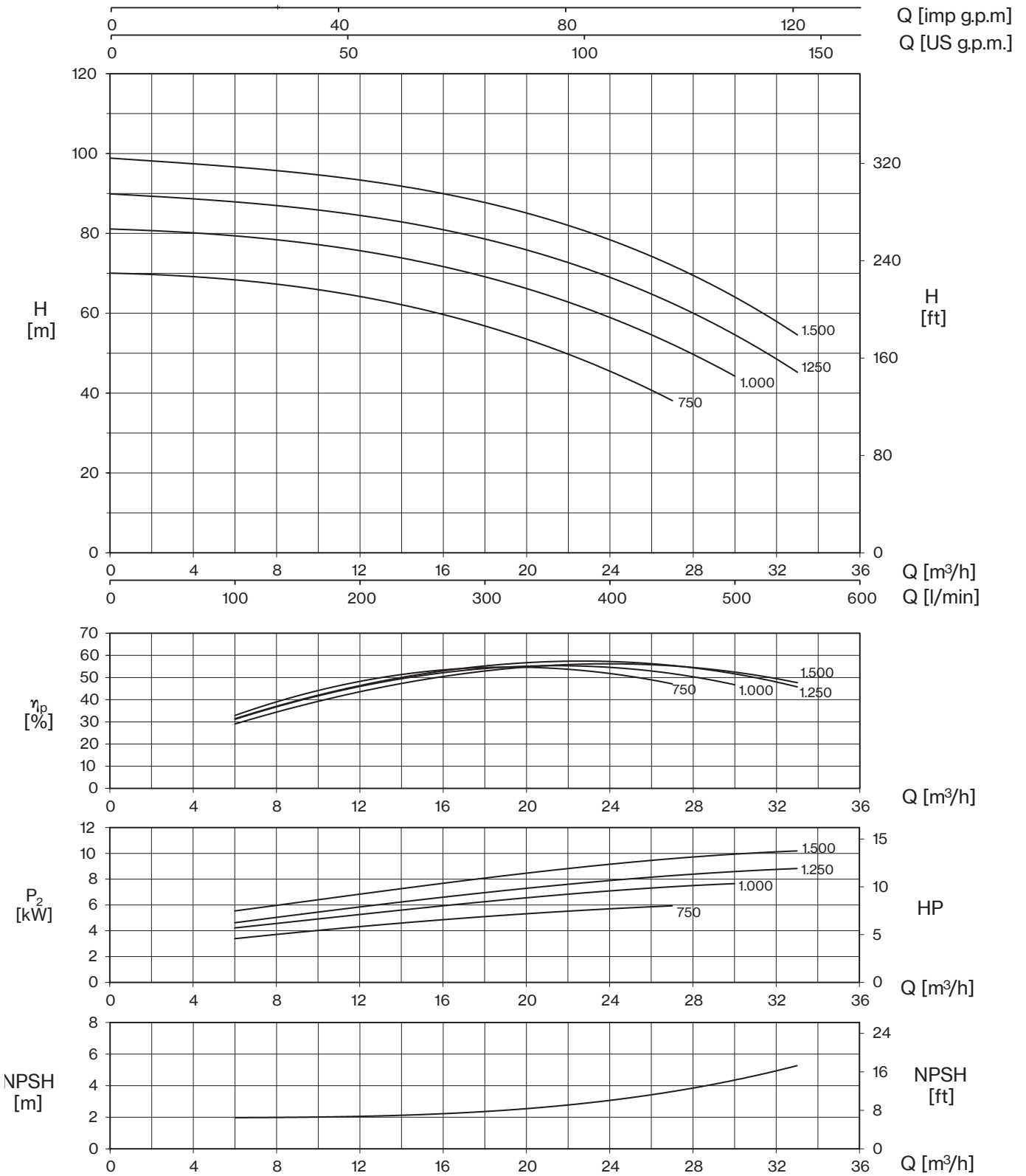

KB



TYPE	P2		P1 (kW)	AMPERE	Q (m³/h - l/min)							
					0	6	12	18	24	27	30	33
	HP	kW	3-	3x400 V 50 Hz	0	100	200	300	400	450	500	550
KB 750 T	7,5	5,5	6,7	11,1	70,0	68,5	63,9	57,1	45,3	38,2		
KB 1000 T	10	7,5	8,5	13,9	80,7	80,4	75,0	68,5	59,7	52,6	43,7	
KB 1250 T	12,5	9,2	9,8	16,3	89,5	88,8	84,1	77,7	69,7	63,0	54,2	45,1
KB 1500 T	15	11,0	11,2	18,6	98,3	97,8	93,5	85,7	78,9	73,3	64,0	54,0

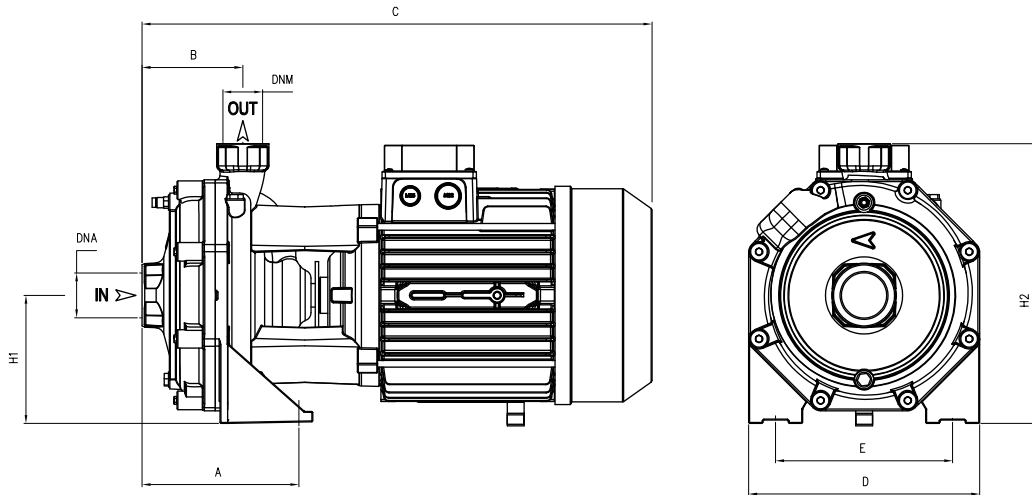



TYPE	DIMENSIONS (mm)													
	A	B	C	D	E	H1	H2	DNA	DNM	I	L	M	kg	T
KB 100	122	72	328	180	140	98	228	1" G	1" G	350	195	265	15,5	T 15
KB 160	115	82	385	210	170	110	265	1" ¼ G		405	225	295	23,5	T 22,5
KB 210	115	82	385	210	170	110	265			405	225	295	24,5	T 23,5
KB 310	115	82	385	210	170	110	265			405	225	295	29,5	T 24,5
KB 400	145	95,5	498	266	212	135	305	1" ½ G	1" ¼ G	553	274	318	48	T 44
KB 600	145	95,5	498	266	212	135	305			553	274	318	56,5	T 48
KB 751 T	145	95,5	532	266	212	135	305			553	274	318	56	
KB 900 T	145	95,5	532	266	212	135	305			553	274	318	62	
KB 800 T	190	120	605	275	210	150	330	2" G	1" ¼ G	722	290	370	78	
KB 1000 T	190	120	605	275	210	150	330			722	290	370	84	
KB 1250 T	190	120	645	275	210	150	330			722	290	370	91,5	
KB 1500 T	190	120	645	275	210	150	330			722	290	370	95,5	